

MA339
P= 377 gr/ml

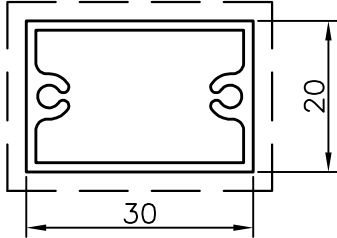

M1475
P= 407 gr/ml

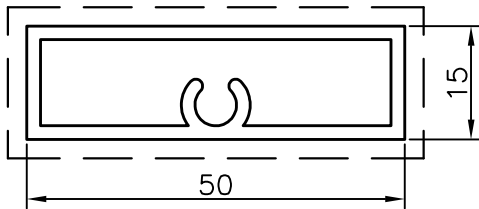

M2029
P= 661 gr/ml

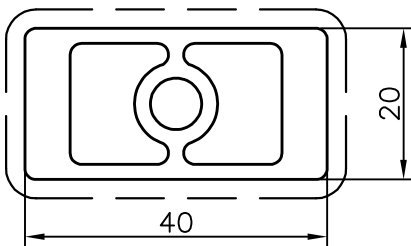

M2591
P= 1143 gr/ml

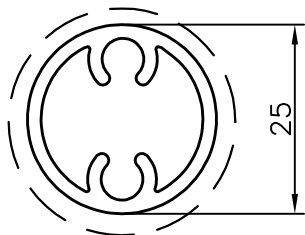

M2030
P= 472 gr/ml

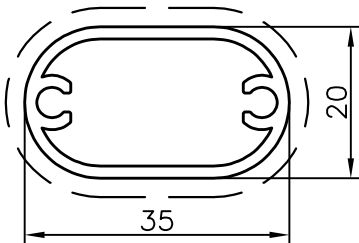

M2590
P= 250 gr/ml

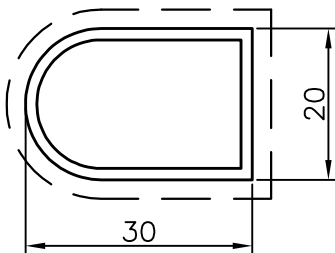

M1856
P= 348 gr/ml

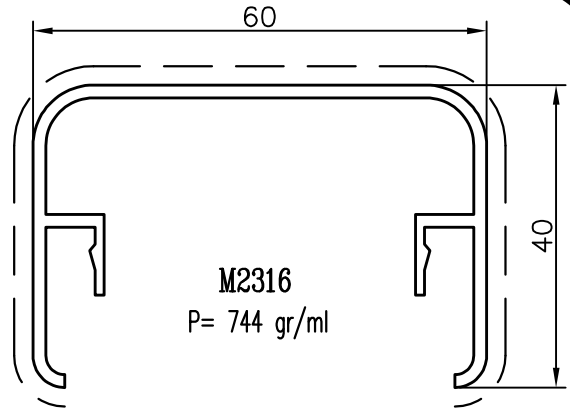

M2316
P= 744 gr/ml

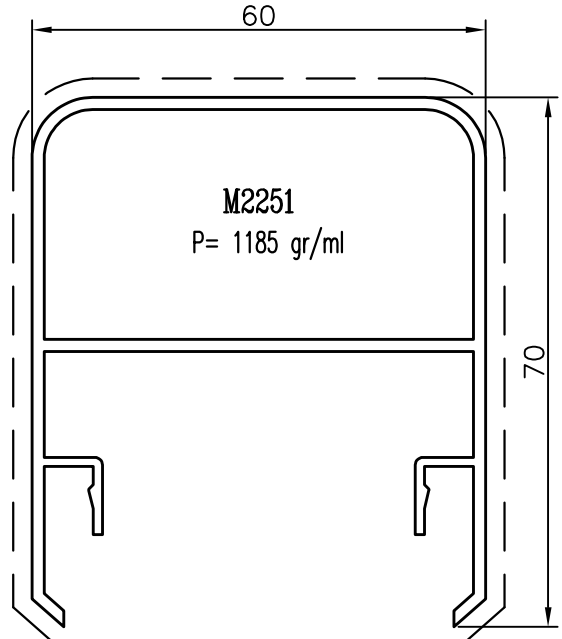

M2251
P= 1185 gr/ml

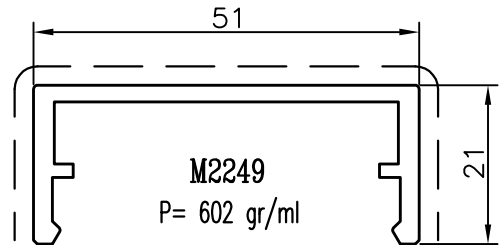

M2249
P= 602 gr/ml

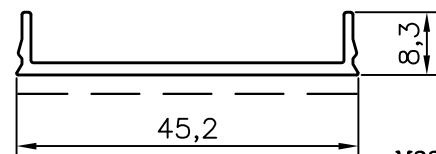

M2250
P= 240 gr/ml

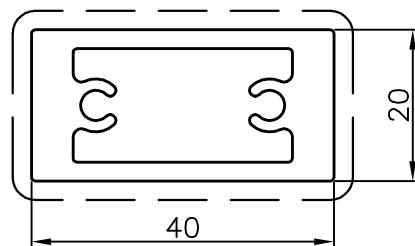

R3933
P= 1103 gr/ml

